

WLCSP54-20

Package Code: UP

WLCSP54-20 (2.57mm x 2.07mm x 0.62mm)

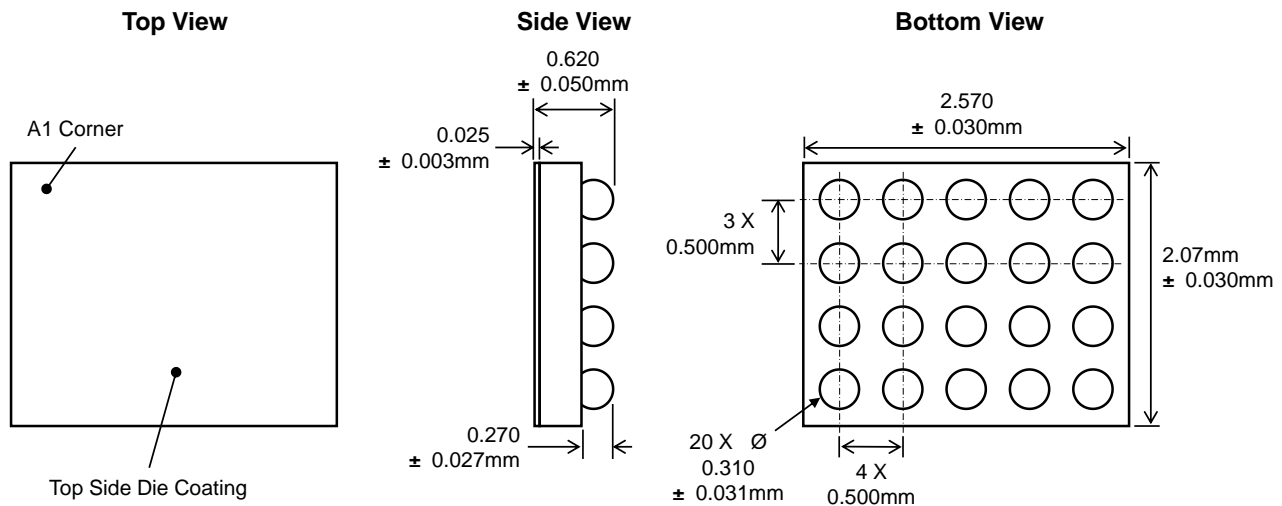

Recommended Footprint

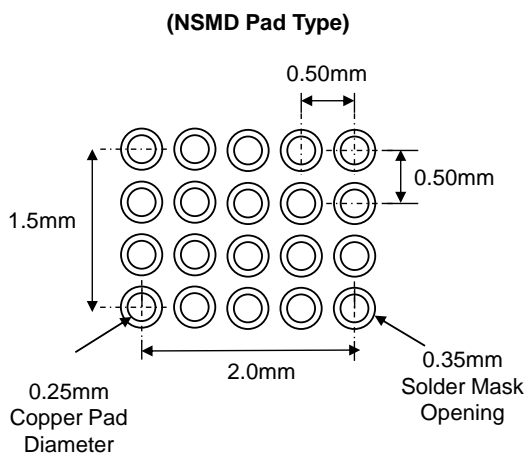

* Dimensions are in millimeters.

Kinetic Technologies cannot assume responsibility for use of any circuitry other than circuitry entirely embodied in a Kinetic Technologies product. No intellectual property or circuit patent licenses are implied. Kinetic Technologies reserves the right to change the circuitry and specifications without notice at any time.