

WLCSP36-18

Package Code: UC

WLCSP36-18 (2.45mm x 1.25mm x 0.620mm)

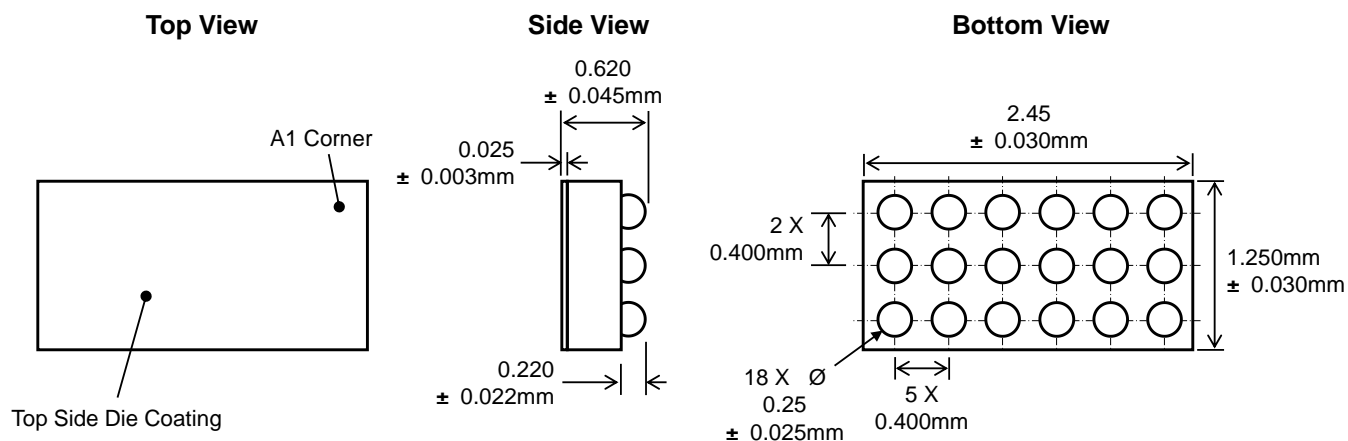

Recommended Footprint

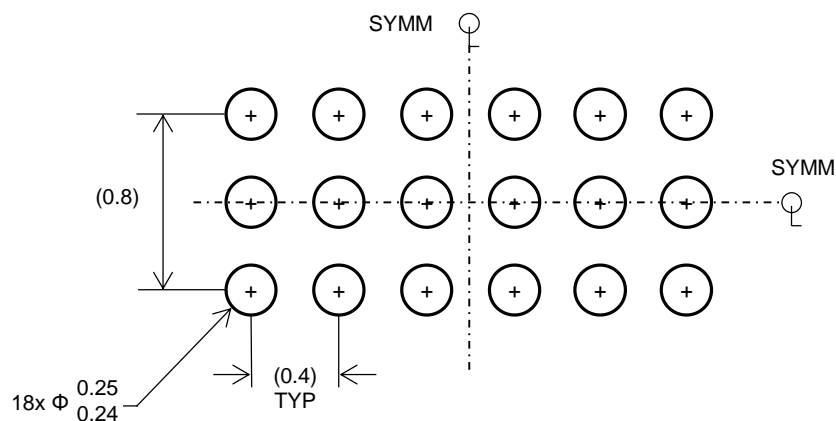

Kinetic Technologies cannot assume responsibility for use of any circuitry other than circuitry entirely embodied in a Kinetic Technologies product. No intellectual property or circuit patent licenses are implied. Kinetic Technologies reserves the right to change the circuitry and specifications without notice at any time.